

Installation Instructions

Cat6a Class EA UTP Field Termination Plug, 568A/568B

Model: N232-USC6A-1

Este manual está disponible en español en la página de Tripp Lite: triplite.com

Ce manuel est disponible en français sur le site Web de Tripp Lite : triplite.com

Русскоязычная версия настоящего руководства представлена на веб-сайте компании Tripp Lite по адресу: triplite.com

Dieses Handbuch ist in deutscher Sprache auf der Tripp Lite-Website verfügbar: triplite.com

WARRANTY REGISTRATION

Register your product today and be automatically entered to win an ISOBAR® surge protector in our monthly drawing!

triplite.com/warranty



1111 W. 35th Street, Chicago, IL 60609 USA
triplite.com/support

Copyright © 2023 Tripp Lite. All rights reserved.

Installation

JACK PIN DESIGNATIONS	TIA / EIA T568A	TIA / EIA T568B	INDUS-TRIAL
	1	White/Green	White/Orange
2	Green	Orange	Orange
3	White/Orange	White/Green	White
6	Orange	Green	Blue
4	Blue		
5	White/Blue		
7	White/Brown		
8	Brown		

Step 1:

Insert cable through cable gland, strip off 1.2 in. (30 mm) of cable jacket. Fan out all four twisted pairs, cut the conductors as shown.

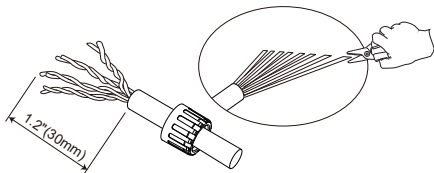

Installation

Step 2:

Follow the color-coding label and insert each conductor into the proper slots on the wiring cap. Trim the ends of excess conductors.

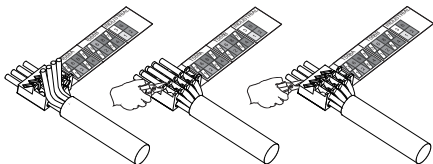

Step 3:

Remove the wiring label before placing the wiring cap on the plug.

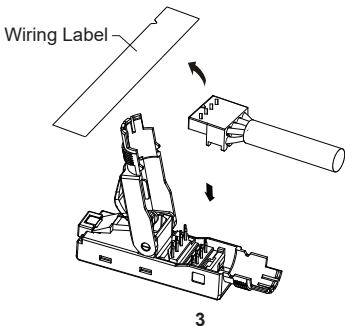

Installation

Step 4:

Place the wiring cap on the plug. Clamp down the wiring cap with pliers until it completely snaps in to establish a connection.

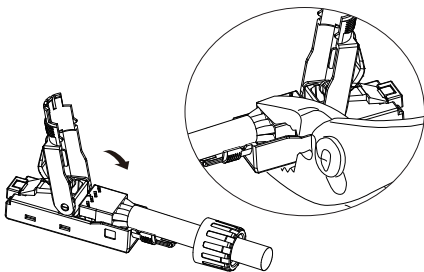

Installation

Step 5:

Close the plug cover and screw on the cable gland to fasten and complete the installation.

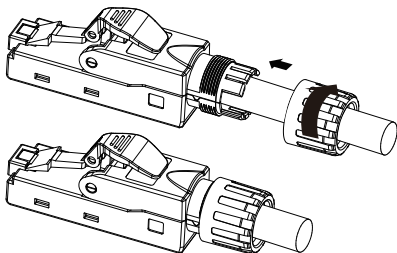

Uninstalling the Cable

Step 1:

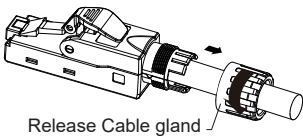

Step 2:

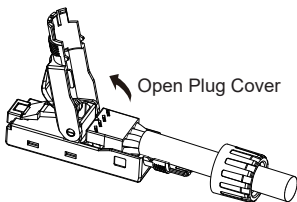

Step 3:

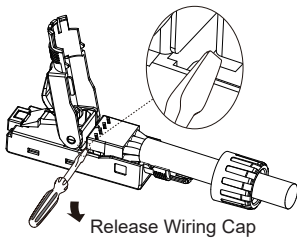

Warranty and Product Registration

Lifetime Limited Warranty

Seller warrants this product, if used in accordance with all applicable instructions, to be free from original defects in material and workmanship for its lifetime. If the product should prove defective in material or workmanship within that period, Seller will repair or replace the product, in its sole discretion. Service under this Warranty can only be obtained by your delivering or shipping the product (with all shipping or delivery charges prepaid) to: TRIPP LITE; 1111 W. 35th Street, Chicago, IL 60609. Seller will pay return shipping charges. Visit tripplite.com/support before sending any equipment back for repair.

THIS WARRANTY DOES NOT APPLY TO NORMAL WEAR OR TO DAMAGE RESULTING FROM ACCIDENT, MISUSE, ABUSE OR NEGLIGENCE. SELLER MAKES NO EXPRESS WARRANTIES OTHER THAN THE WARRANTY EXPRESSLY SET FORTH HEREIN.

EXCEPT TO THE EXTENT PROHIBITED BY APPLICABLE LAW, ALL IMPLIED WARRANTIES, INCLUDING ALL WARRANTIES OF MERCHANTABILITY OR FITNESS, ARE LIMITED IN DURATION TO THE WARRANTY PERIOD SET FORTH ABOVE; AND THIS WARRANTY EXPRESSLY EXCLUDES ALL INCIDENTAL AND CONSEQUENTIAL DAMAGES. (Some states do not allow limitations on how long an implied warranty lasts, and some states do not allow the exclusion or limitation of incidental or consequential damages, so the above limitations or exclusions may not apply to you. This Warranty gives you specific legal rights, and you may have other rights which vary from jurisdiction to jurisdiction.)

WARNING: The individual user should take care to determine prior to use whether this device is suitable, adequate or safe for the use intended. Since individual applications are subject to great variation, the manufacturer makes no representation or warranty as to the suitability or fitness of these devices for any specific application.

PRODUCT REGISTRATION

Visit tripplite.com/warranty today to register your new Tripp Lite product. You'll be automatically entered into a drawing for a chance to win a FREE Tripp Lite product!*

* No purchase necessary. Void where prohibited. Some restrictions apply. See website for details.

Warranty and Product Registration

Regulatory Compliance Identification Numbers

For the purpose of regulatory compliance certifications and identification, your Tripp Lite product has been assigned a unique series number. The series number can be found on the product nameplate label, along with all required approval markings and information.

When requesting compliance information for this product, always refer to the series number. The series number should not be confused with the marketing name or model number of the product.

Tripp Lite has a policy of continuous improvement. Specifications are subject to change without notice.



1111 W. 35th Street, Chicago, IL 60609 USA
tripplite.com/support